

rossin

design

culture

since

1964





here
comes
the
soul

”

Dal 1964 Rossin è alla costante ricerca di un design di qualità in ogni ambiente sia pubblico sia privato. Per noi design non significa solo bellezza della forma ma, soprattutto, sensazione di benessere. Benvenuti nel mondo Rossin.

Since 1964 Rossin has been seeking a quality design in the contract and residential sectors. For us, good design means not only beauty of form but, above all, a feeling of wellness. Welcome to the Rossin world.

Seit 1964 steht Rossin für hochwertiges Design im Objekt- und Privatbereich. Und das bedeutet für uns nicht nur Formschönheit. Menschen die mit Rossin Möbel leben, wollen sich vor allem wohlfühlen. Willkommen in der Welt von Rossin.



Klaus Pomella
Owner

contents

COCO 12-17



n@t 18-21



monte 22-25



cleo 26-31



atoma 32-35



tonic metal 36-39



tonic wood 40-43



alea 44-47



orizzonte 48-51



sinuè 52-53



cat 54-57



sofie 58-65



p@d 66-69



luc 70-75



dimon 76-79



antea 80-83



mint 84-87

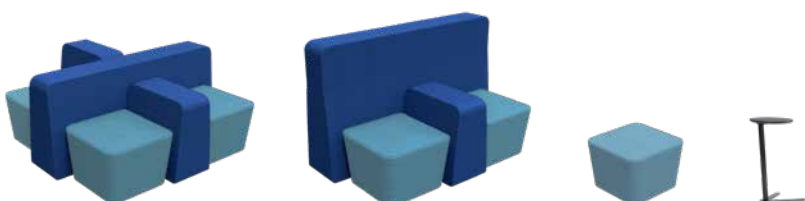

aris 88-93



riffel 94-97



orbis 98-101



diana 102-105



deco 106-109



tables 110-111

stools 112-113

designers 114-115

details 116-123

the
new
soft





reddot design award
winner 2009

COCO

design / Lorenz+Kaz



Coco unisce eleganza e spirito cosmopolita con la sensazione di sentirsi protetto.

Coco is a mixture of elegance and cosmopolitan openness with the feeling of protection.

Coco verbindet Eleganz und Weltoffenheit mit einem Gefühl für Geborgenheit.









work place balance

Reserve Collection





reddot design award
honourable mention 2010

n@t

design / Martin Ballendat





Confortevole, pratica e compatta. N@t è la soluzione perfetta per le zone lounge e relax.

Comfortable, easy and compact. N@t is perfect for lounge and relax areas.

Bequem, praktisch und raumsparend. N@t stellt sich den Anforderungen öffentlicher Räume.



the
space
between





monte

design / Christian Werner





Un classico reinterpretato in chiave moderna. Ecco Monte.

A modern interpretation of a classic item. This is Monte.

Klassisch gefertigt, modern interpretiert. Das ist Monte.





time
is too
short



cleo

design / Archirivolto



Cleo, perfetto e comodo rifugio per lasciarsi ispirare.

Cleo, the perfect comfort zone to find inspiration.

Cleo inspiriert, ist komfortabel und als Rückzugsort perfekt geeignet.







Cleo, estremamente versatile con le sue varianti.
Cleo, always matching thanks to the different versions.
Perfekt kombinierbar. Die vielfältigen Varianten von Cleo.





lobby
lounge
love



atoma

design / Denis Santachiara





Atoma si integra con discrezione e consente un utilizzo creativo degli spazi.
Atoma fits with discretion allowing a creative use of the spaces.
Kreative Raumnutzung. Atoma integriert sich dezent.



Da sola o in compagnia. Atoma abita i propri spazi.

Single or in company. Atoma lives its spaces.

Allein oder zusammen. Atoma lebt mit ihrer Umgebung.



we're
not the
same



tonic metal

design / Lorenz+Kaz



Dinamica, interessante e versatile.
Tonic convince con il suo carattere.

Dynamic, interesting and versatile.
Tonic assures with its own character.

Dynamisch, interessant und variantenreich.
Tonic überzeugt mit seinem eigenen Charakter.





the wood way

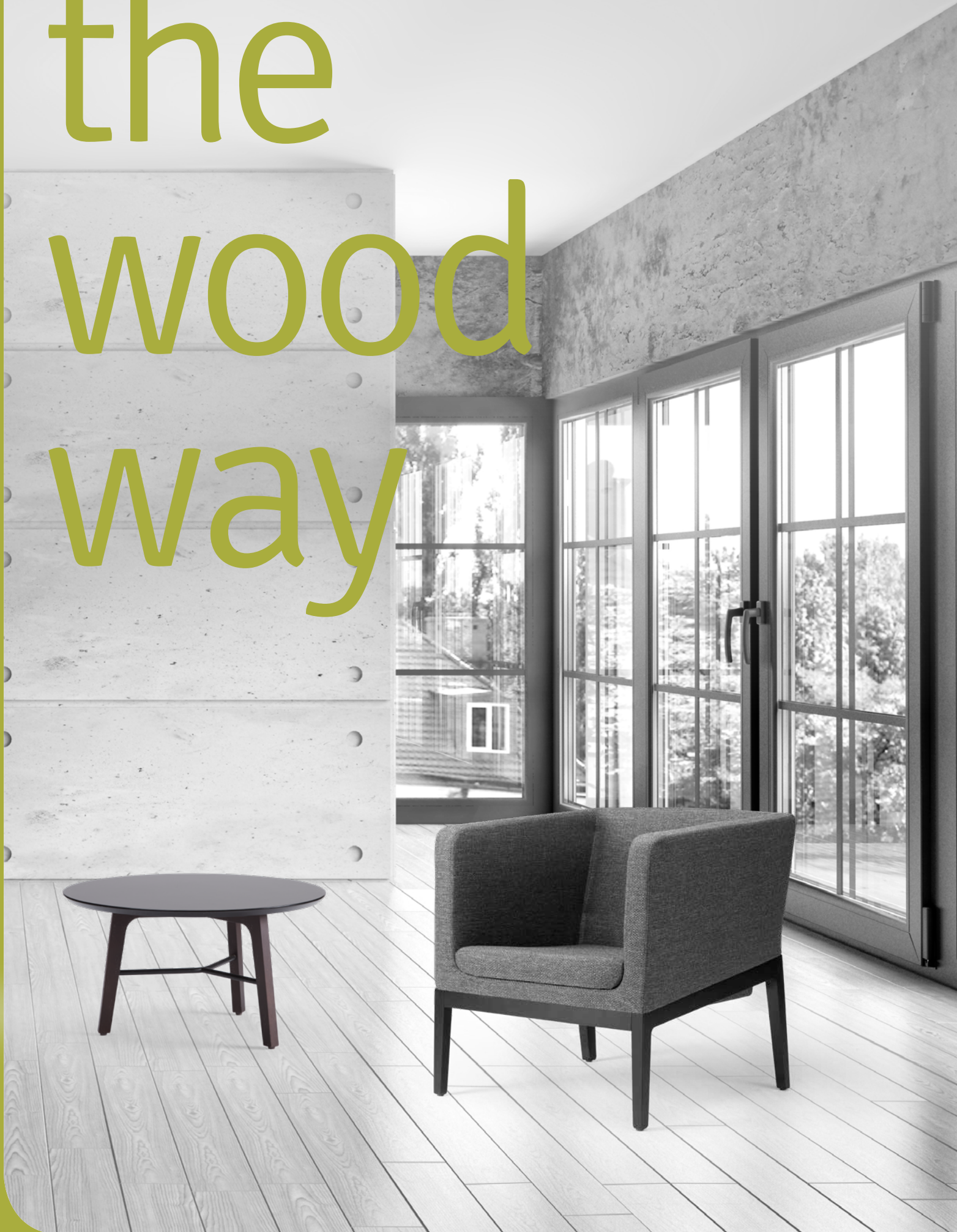

tonic wood

design / Lorenz+Kaz



rossin / tonic wood





feel
the
form



alea

design / Lepper Schmidt Sommerlade



Tutto parte da un semplice dado. Scomponendo e
ri assemblando superfici e volumi nasce Alea.

It all starts from a simple dice. Surfaces and volumes
are taken apart and re-assembled to form Alea.

Ein einfacher Würfel ist der Anfang. Durch Zerlegen
und wieder Zusammenfügen einzelner Flächen und
Volumen wird aus der Urform Alea.







endless
style

orizzonte

design / Luca Scacchetti



Uno statement.
Orizzonte dalle linee chiare e design purista.

Clear lines and puristic design.
Orizzonte is a statement.

Klare Linien, puristisches Design.
Orizzonte ist ein Statement.





lay
back



sinuè

design / Rossin



Sinuè per sdraiarsi e rilassarsi.

Sinuè to lay back and relax.

Sinuè heißt Zurücklehnen und Genießen.

only
one
idea



cat

design / Wolfgang C.R. Mezger



Cat è una scultura, che si sviluppa da un quadrato inarcato e si apre conicamente come un fiore.

Cat is a seating sculpture which develops from an arched quadrate and opens up conically like a flower.

Cat ist eine Sitzskulptur, die sich aus einem gewölbten Quadrat entwickelt und sich dabei konisch wie eine Blüte öffnet.





dine
and
shine







Modesta. Esteticamente bella. Accogliente.
Modest. Well-shaped. Comfortable.
Unauffällig. Formschön. Gemütlich.



sofie

design / guggenbichlerdesign...











Dettagli femminili con particolari tagli di luce posteriori. Sofie concede una seduta elegante e piacevole.

Feminine details with the distinctive and breezy cut-outs in the back. Sofie allows a stylish and enjoyable stay.

Feminine Details mit markant luftigen Ausschnitten am Rücken. Sofie steht für stilvolles Verweilen.

work
every
where





Eclettico, ricco di dettagli e comunicativo. P@d è geniale.

Eclectic, rich in details and communicative. P@d is smart.

Vielseitig, detailreich und kommunikativ. P@d ist genial.







go
with
the
flow



reddot design award
winner 2013



luc

design / Lorenz+Kaz







Lasciatevi portare da Luc.
Come una vela al vento.

Let you carry by Luc.
Like a sail in the wind.

Lassen Sie sich von Luc tragen.
Wie ein Segel im Wind.







inspired
by
nature





dimon

design / Erla Sólveig Óskarsdóttir



Dimon è l'esatto contrario in perfetta armonia.

Dimon is the exact opposite in perfect harmony.

Dimon ist ein Widerspruch, der perfekt harmoniert.





state of the art



antea

design / Martin Ballendat





Squadrato, pratico e di una bellezza senza tempo.
Antea è questo.

Quadrat, practical with a timeless beauty.
This is Antea.

Quadratisch, praktisch, zeitlos schön.
Das ist Antea.



rossin / antea

enjoy
your
flight



mint

design / Lorenz+Kaz

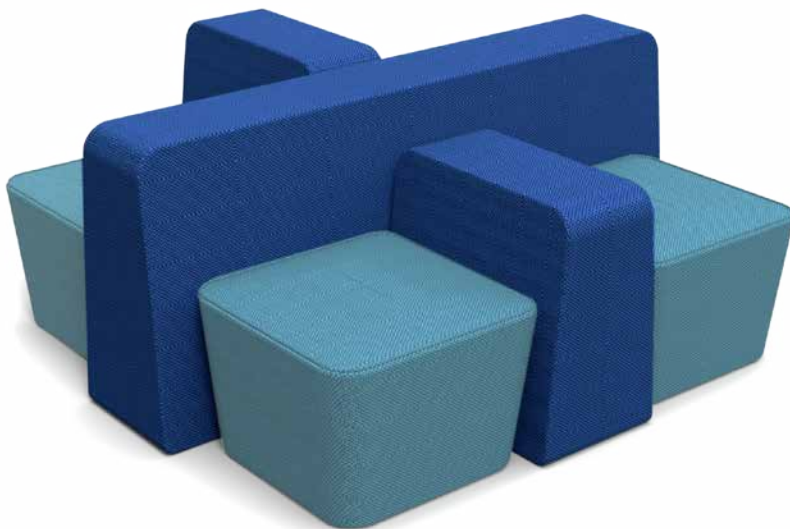
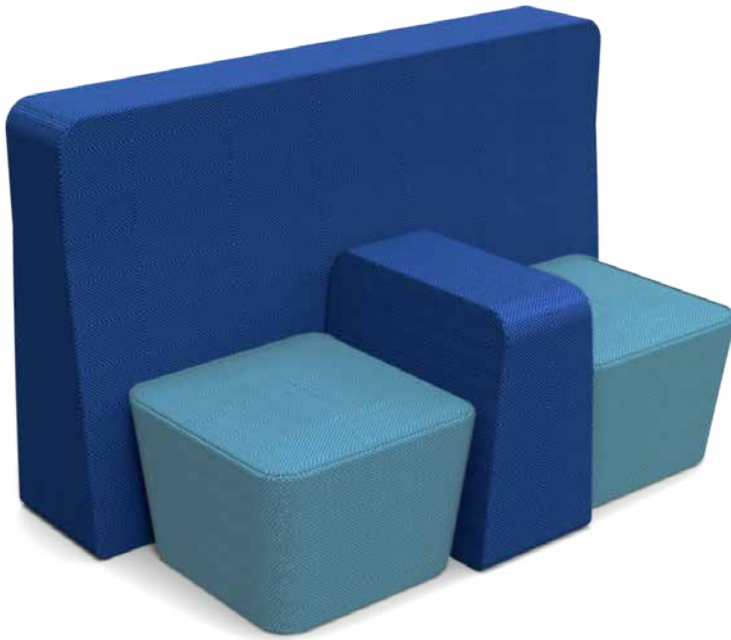

Mint permette diverse combinazioni di forme, colori ed elementi.
Mint allows multiple design options of forms, colours and structures.
Mint bietet Gestaltungsfreiheit. Ob in Form, Farbe oder Struktur.

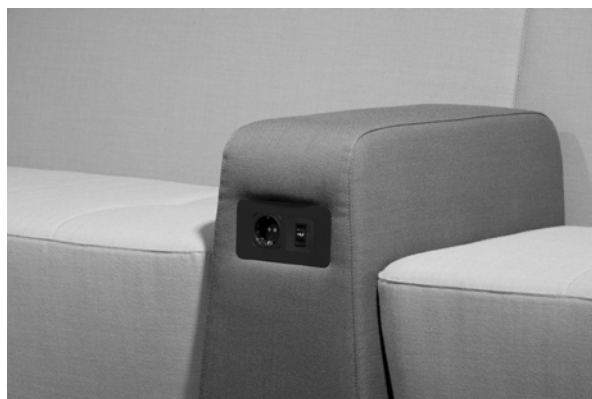



it's a
love
story

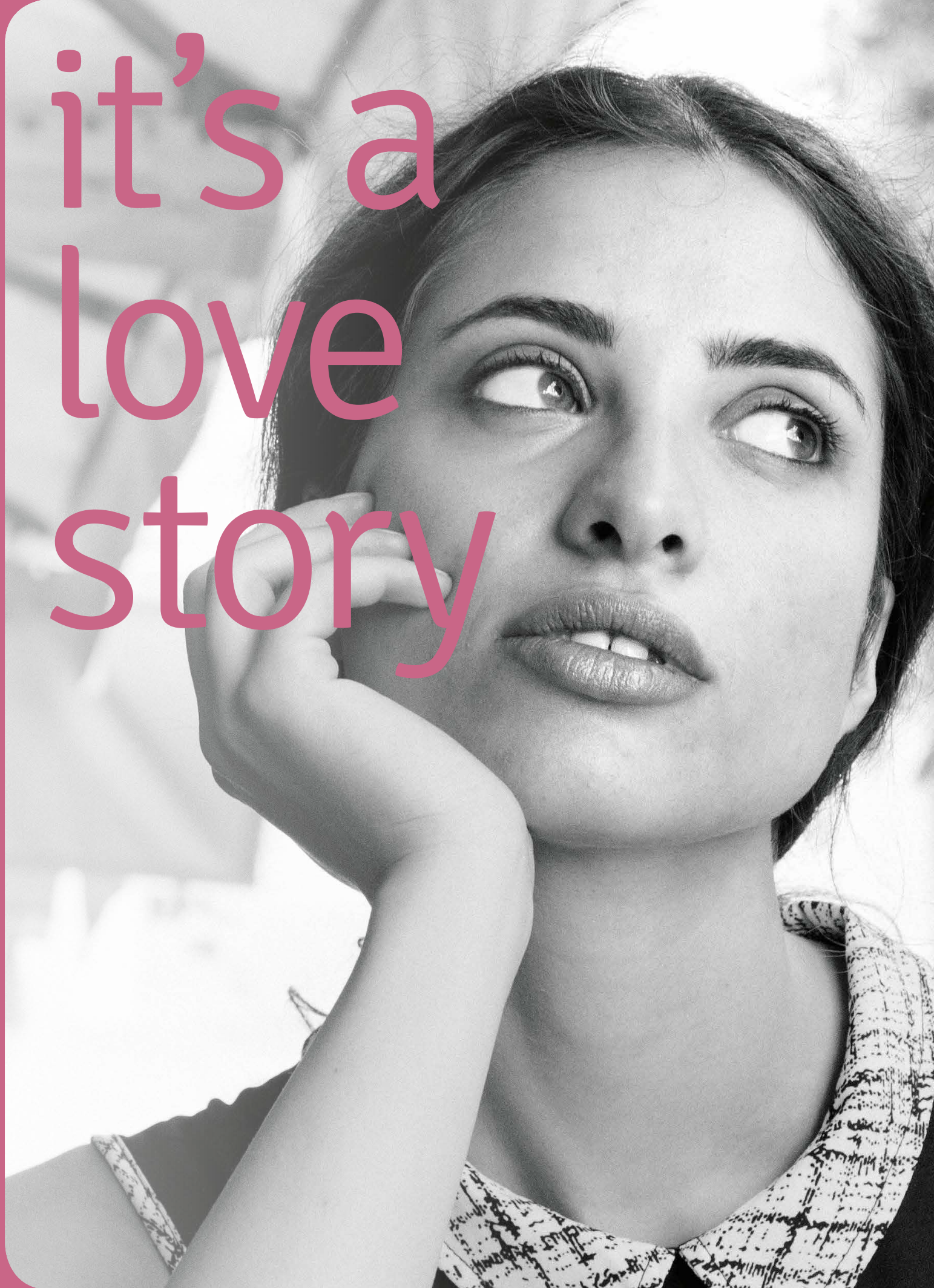

aris

design / Archirivolto



Una collezione di sedute flessibile Aris soddisfa egregiamente ogni esigenza d'arredo funzionale lounge e dining, in quanto disponibile con diverse altezze, tipologie braccioli ed inclinazioni seduta.

A flexible seating collection Aris is the ideal partner for lounge and dining purposes thanks to the different armrest variants, seats heights and back inclinations.

Aris ist eine flexible und vielfältig passende Sitzkollektion. Mit unterschiedlichen Armlehnvarianten, Rückenhöhen, sowie unterschiedlichen Sitz-Höhen und Rückenneigungen ist Aris in zwei Versionen Lounge und Dining erhältlich.









think
time
less

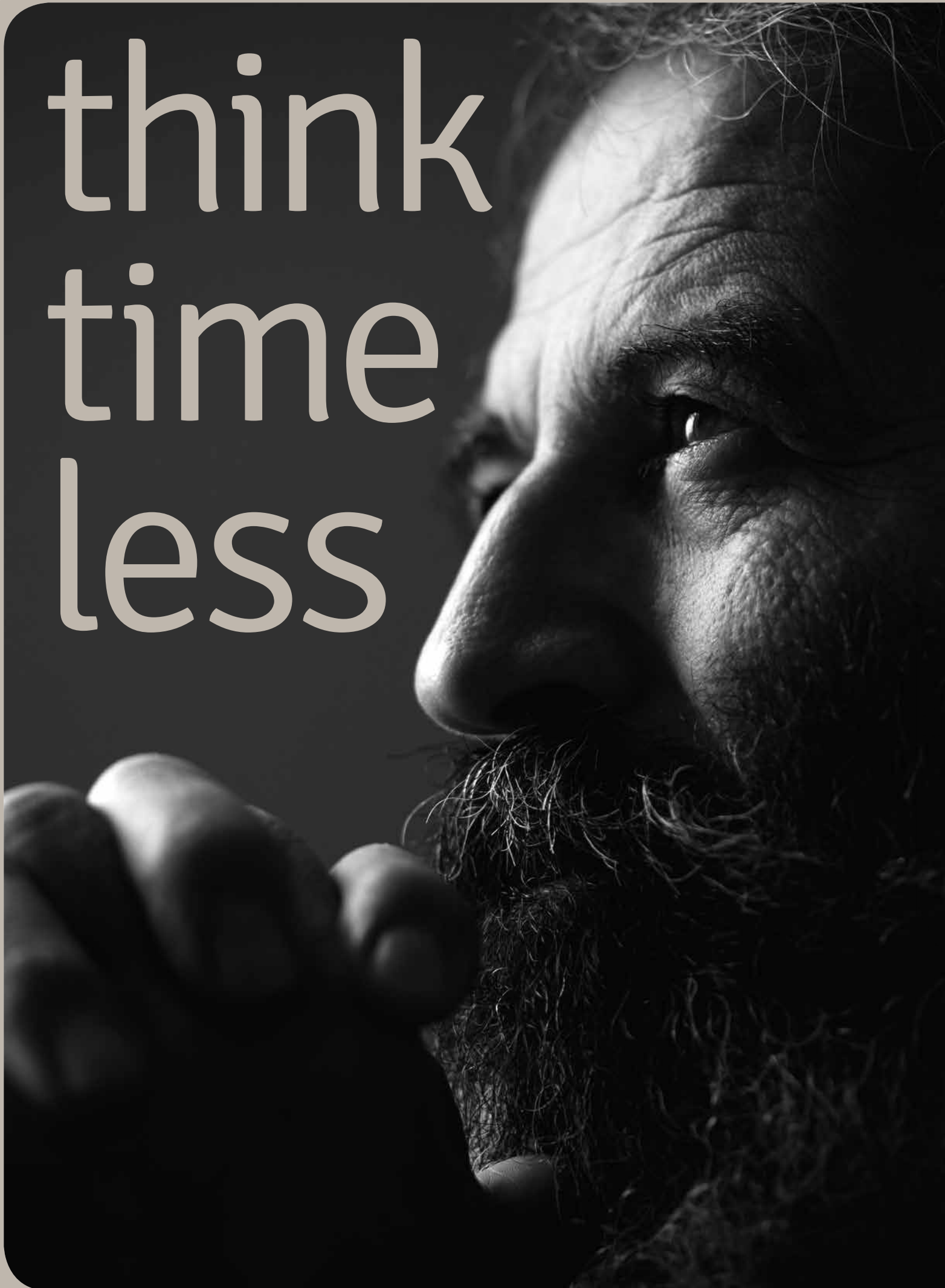

riffel

design / Sven Dogs



Moderna interpretazione dello stile ed il gusto dei tempi passati.
Riffel rappresenta l'eleganza degli anni 50 e 60.

A new interpretation of the flair and taste of the past times.
Riffel represents the elegance of the '50s and '60s.

Flair und Geschmack aus alten Zeiten, neu interpretiert.
Riffel verkörpert die Eleganz der 50er und 60er Jahre.





look
forward



orbis

design / Wolfgang C.R. Mezger



Orbis: funzionalità elevata e comfort perfetto.

Orbis: high functionality combined with perfect seating comfort.

Bei Orbis trifft genialer Sitzkomfort auf durchdachte Funktion.





since
1964



diana

design / Rossin



La prima seduta del marchio Rossin. Moderna come non mai.

The first seat made by Rossin. More modern than ever before.

Das erste Rossin Sitzmöbel. Moderner denn je.





choose
your
style



deco

design / Rossin



Deco: spazio alla creatività e al comfort.

Deco: space for creativity and comfort.

Deco bietet Platz für Kreativität. Und schafft Raum für Gemütlichkeit.





Ogni sedia ha il suo tavolo!
Rossin ha sempre la soluzione.
Every chair has its table! Rossin
finds always the right solution.
Selbstverständlich. Rossin
bietet immer den passenden
Tisch zum Möbel.



every
chair
has its
table

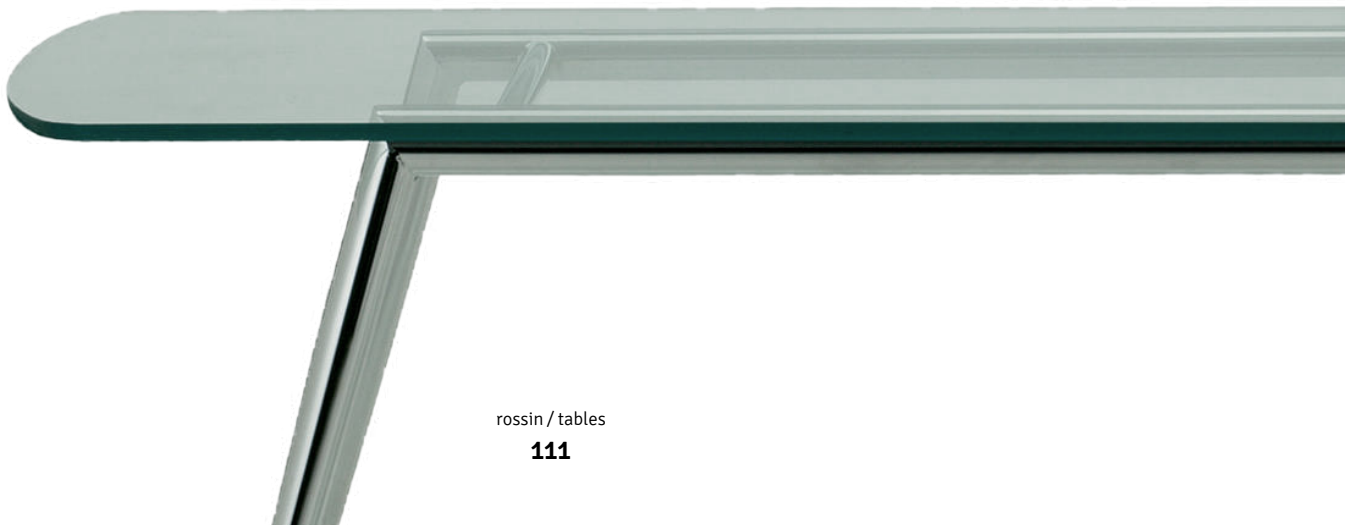

size matters





Parte di ogni collezione.
Il pouf.

Part of every collection.
The stool.

Teil jeder Kollektion.
Der Hocker.



the rossin designers



Archirivolto

Il duo italiano di designer toscani. Creativi e brillanti con la passione per i dettagli.

The Italian designer duo from Tuscany. Creative and brilliant with a passion for details.

Das Italienische Design-Duo mit Sitz in der Toskana. Kreativ, verrückt und mit Liebe zum Detail.



Wolfgang C.R. Mezger

Il designer crea concetti innovativi e poetici traducendoli in prodotti longevi, funzionali e di facile impiego per una clientela internazionale.

The designer has drawn up innovative and poetic design concepts and turned them into long-life, functional and user-friendly products for international customers.

Der Designer arbeitet mit Leidenschaft im Einsatz für innovative und poetische Designkonzepte, sowie deren Umsetzung in langlebige, funktionelle und benutzerfreundliche Produkte für internationale Klienten.



Martin Ballendat

Un designer rinomato con l'attitudine alla funzionalità.

A renowned designer with an attitude toward functionality.

Ein renommierter Designer mit Hang zur Funktionalität.



guggenbichler design...

Il duo di design tedesco combina armonia e creatività con strutture chiare e pulite.

The German designer duo combines harmony, creativity and clear structures.

Das deutsche Design-Duo vereint Harmonie, Kreativität und klare Strukturen.



Lorenz+Kaz

Dalla Germania a New York fino a Londra. Il duo di designer lavora insieme dal 2001 in tutto il mondo.

From Germany to New York and then to London. The designer duo works together since 2001 with partners from all over the world.

Von Deutschland über New York bis London. Das Design-Duo arbeitet seit 2001 gemeinsam und weltweit.



Erla Sólveig Óskarsdóttir

La designer islandese lavora dalla sua terra natia in tutto il mondo.

The Icelandic designer works from her country around the world.

Die isländische Designerin arbeitet von Ihrer Heimat aus in der ganzen Welt.

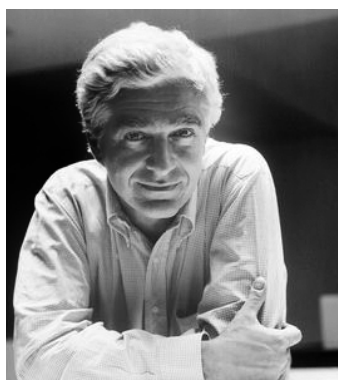

Luca Scacchetti

Il designer di mobili e architetto milanese che mescolava abilmente le due discipline nella sua attività.

The furniture designer and architect who mixed skilfully both disciplines in his activity.

Der Mailänder Möbeldesigner und Architekt vermischte gekonnt beide Disziplinen.



Christian Werner

Da più di 25 anni si occupa di product ed interior design alla ricerca di nuove soluzioni.

He has been working for 25 years as product and interior designer looking for new solutions.

Seit über 25 Jahren beschäftigt sich der Designer mit Raumkonzepten. Und wie man diese neu entdecken kann.



Lepper, Schmidt, Sommerlade

I tre protagonisti complementari con le loro diverse competenze che si ritrovano nella qualità senza compromessi dei loro prodotti.

The three actors complementary with their different capabilities to be found in the quality without compromise of their products.

Die drei Akteure mit ergänzenden Fähigkeiten, die sich einig sind über die kompromisslose Qualität ihrer Produkte.



Denis Santachiara

Eccentrico e outsider. Denis Santachiara vive tra Arte e Design.

Between art and design. Denis Santachiara an outsider and eccentric designer.

Ausgefallen und losgelöst. Denis Santachiara lebt zwischen Kunst und Design.



Sven Dogs

Creatività e competenze tecniche con la passione del design. Sven Dogs arrivato a Vienna dopo un lungo peregrinare sorprende ogni volta con qualcosa di nuovo.

Creativity and technical abilities with the passion for design. Sven Dogs, after long wanderings landed to Vienna, surprises each time with something new.

Kreativ, technisch begabt und die Leidenschaft etwas zu erschaffen. Über Umwege in Wien gelandet, überrascht Sven Dogs jedes Mal aufs Neue.

details

alea Lepper, Schmidt, Sommerlade / 44 - 47

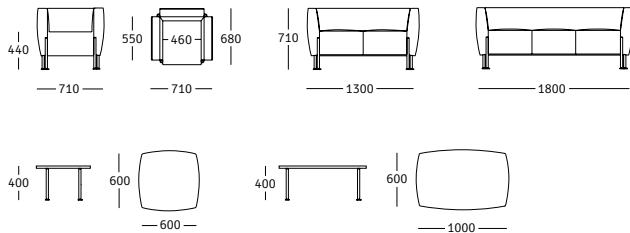

antea Martin Ballendat / 80 - 83

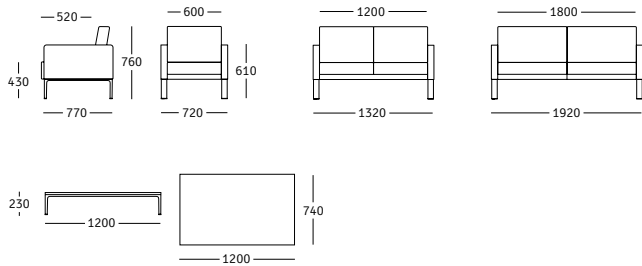

aris Archirivolto / 88 - 93

Lounge

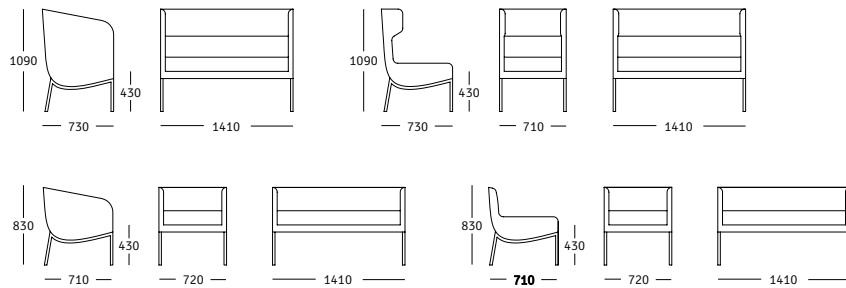

Dining

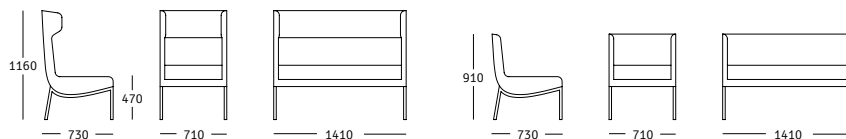

cleo Archirivolto / 26 - 31

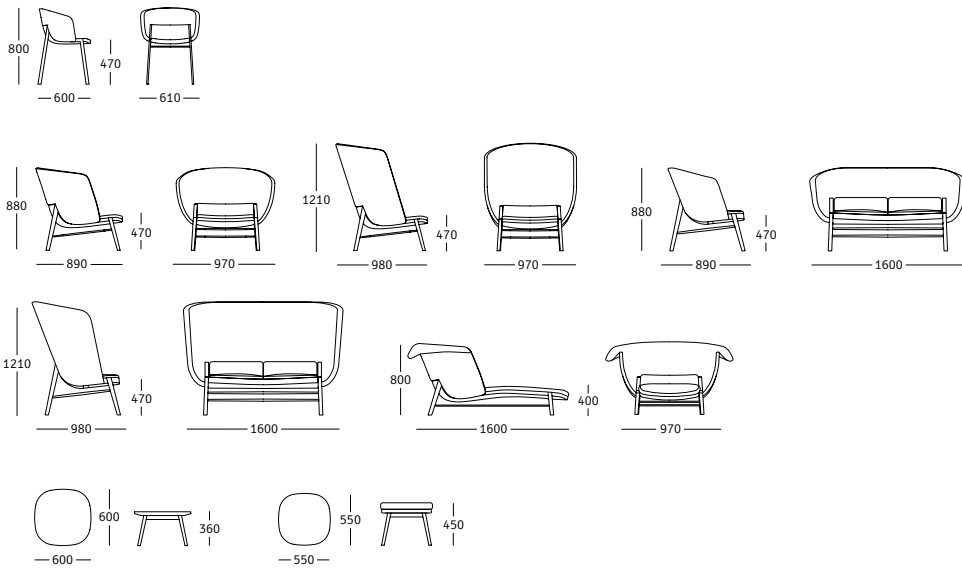

COCO Lorenz+Kaz / 12 - 17

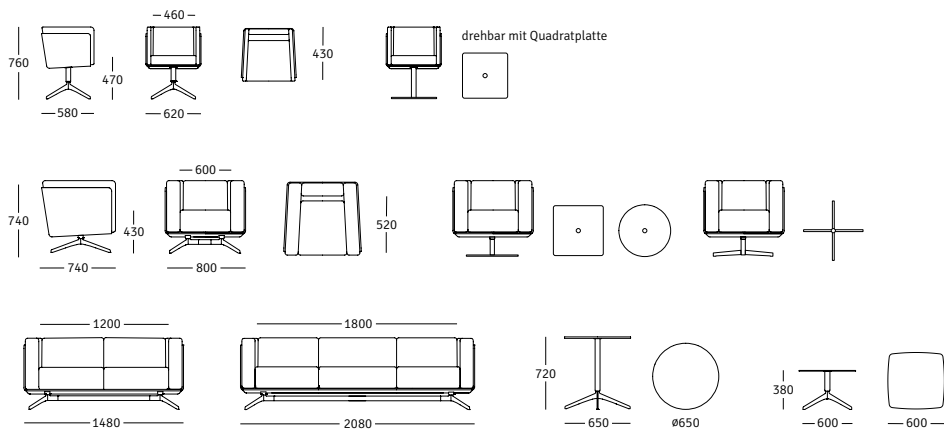

deco Rossin / 106 - 109

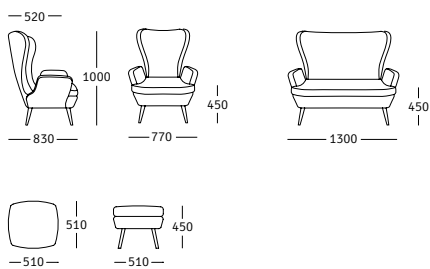

diana

Rossin / 102-105

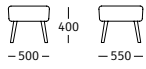
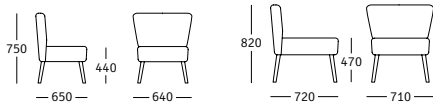

dimon

Erla Sólveig Óskarsdóttir / 76-79

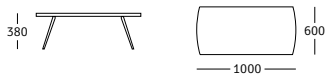
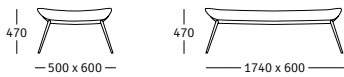
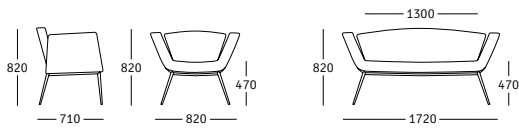

luc

Lorenz+Kaz / 70-75

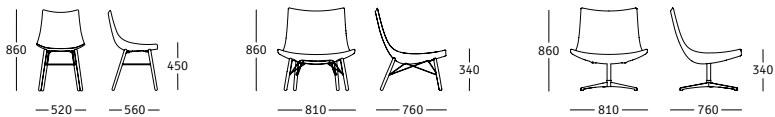
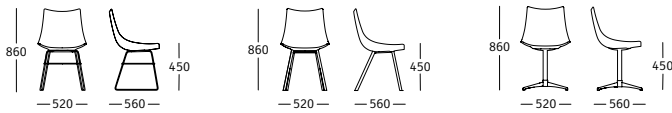

mint

Lorenz+Kaz / 84-87

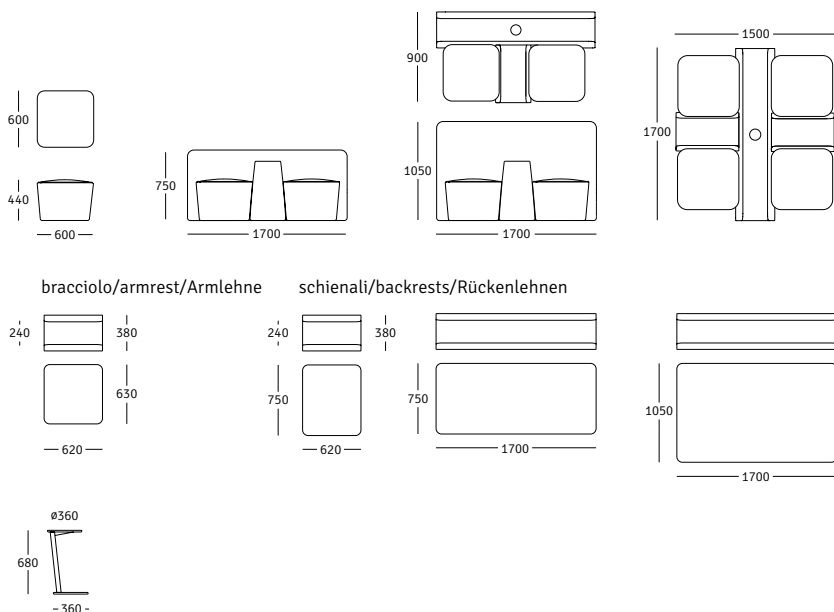

monte

Christian Werner / 22 - 25

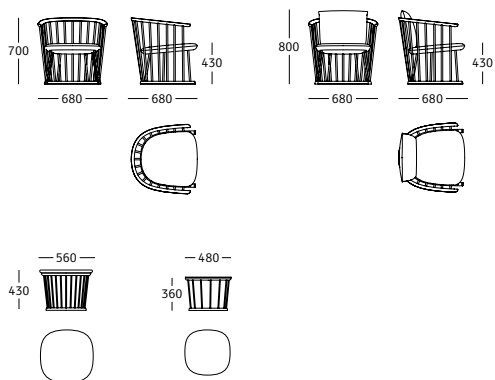

n@t

Martin Ballendat / 18-21



orbis Wolfgang C.R. Mezger / 98-101

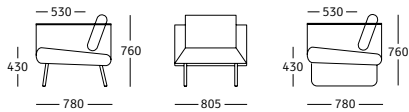

base 4 gambe/4 feet base/4-Fuß Untergestell

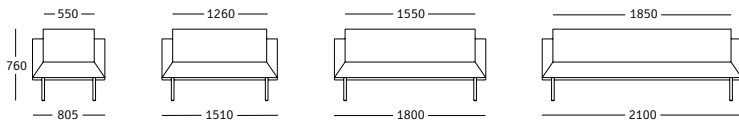

base a slitta/sled base/Kufenfuß Untergestell

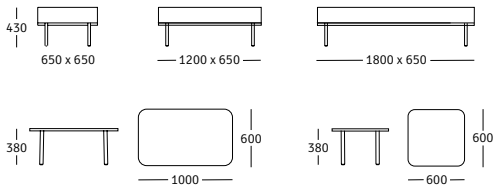
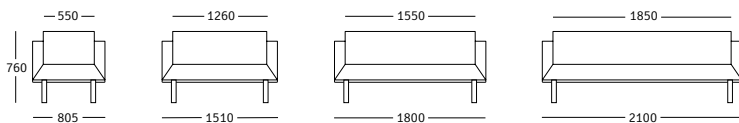

orizzonte Luca Scacchetti / 48-51

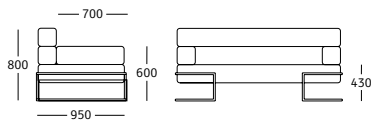

senza braccioli/without armrests/ohne Armlehnen

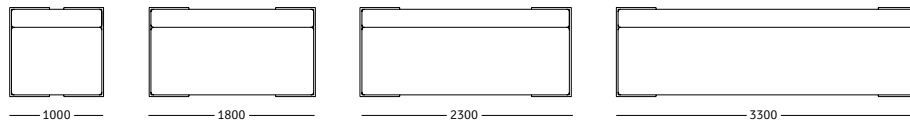

con braccioli/with armrests/mit Armlehnen

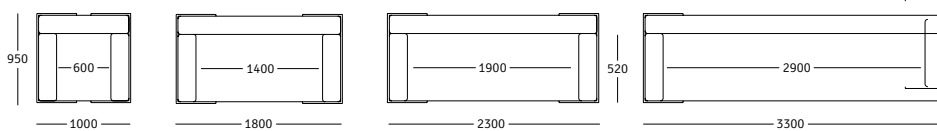

pouf/stool/Hocker

panca/bench/Bank

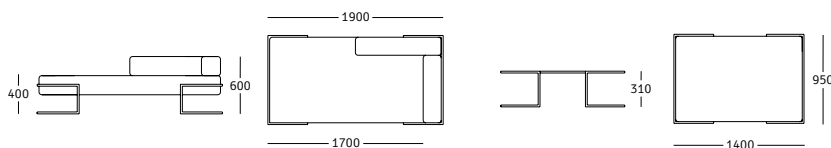
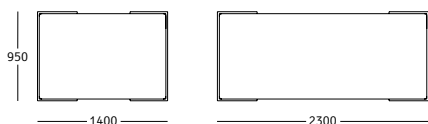

p@d Martin Ballendat / 66-69

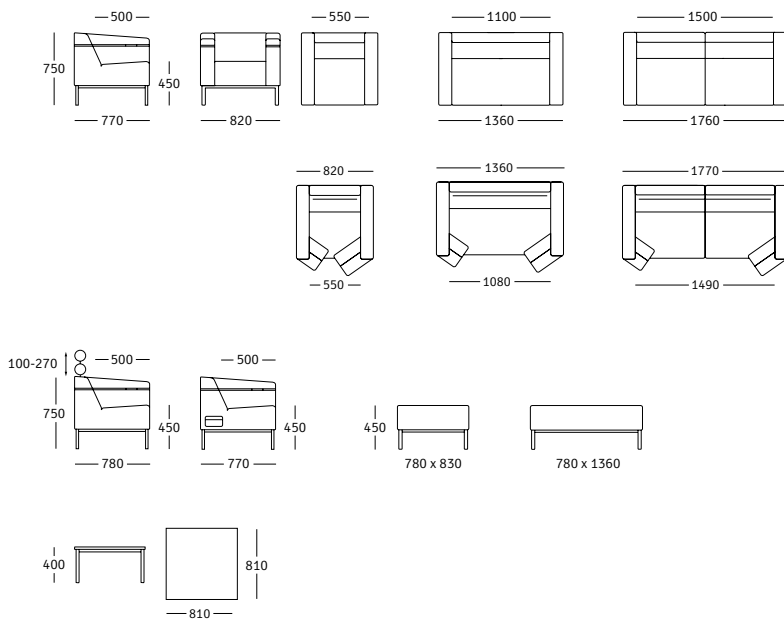

riffel Sven Dogs / 94-97

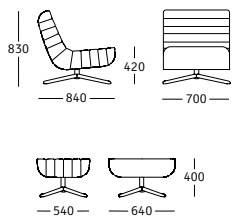

sinuè Rossin / 52-53

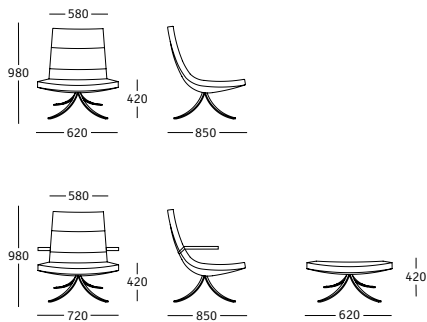

sofie guggenbichlerdesign... / 58-65

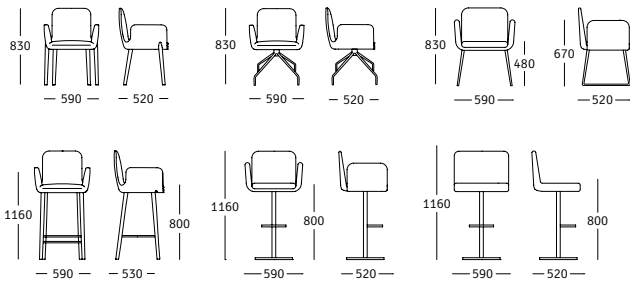

tonic metal Lorenz+Kaz / 36-39

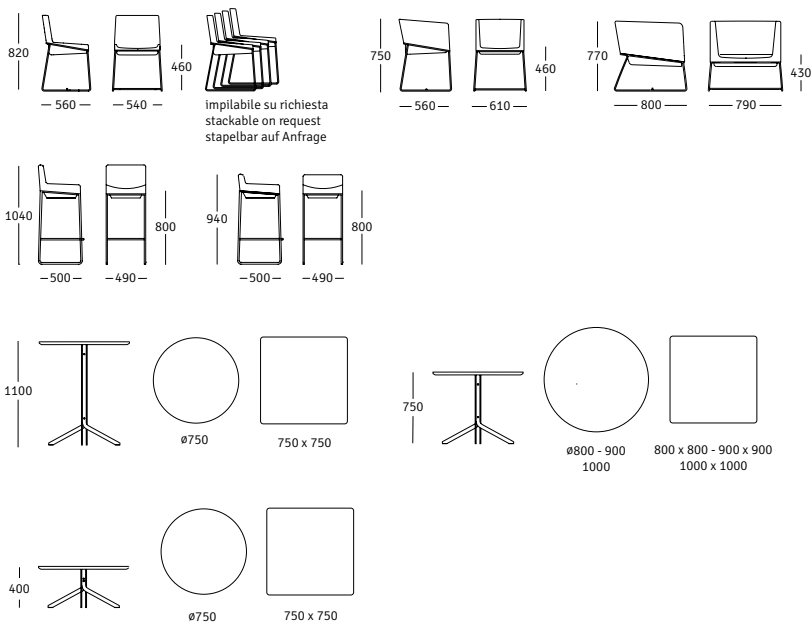

tonic wood Lorenz+Kaz / 40-43

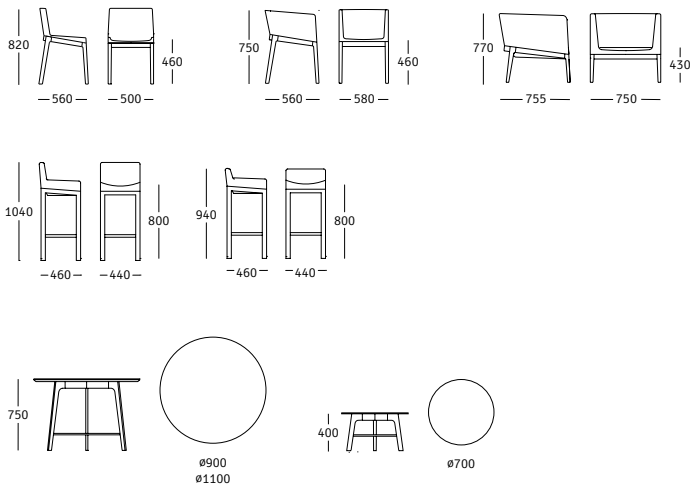

world wide work



Dall'Italia in oltre 30 Paesi del mondo.

From Italy in more than 30 countries around the world.

Von Italien in über 30 Länder weltweit.

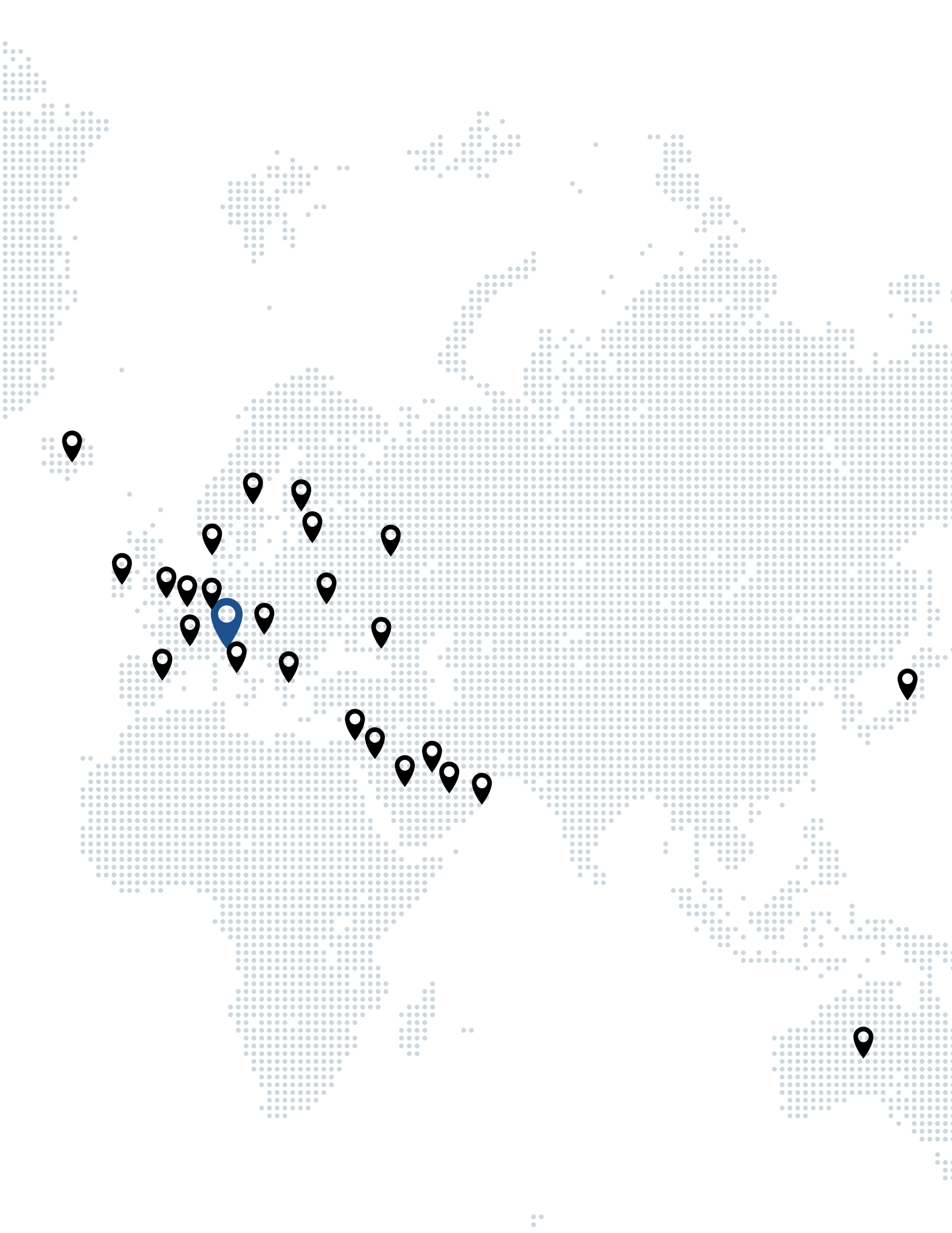

impressum

Herausgeber:
Rossin Srl / GmbH
Via Nazionale 2/2 – Reichsstraße 2/2
39044 Egna-Laghetti (BZ) – Neumarkt Laag
Italia – Italien

No. 01, Oktober 2018

Subject to changes and misprints.

Grazie ai nostri clienti e ai fotografi per le immagini fornite.

Thanks to all our clients and photographers.

Vielen Dank an unsere Kunden und Fotografen für die Referenzbilder.

Rossin Srl / GmbH
Via Nazionale 2/2 – Reichsstraße 2/2
39044 Egna-Laghetti (BZ) – Neumarkt Laag
Italia – Italien

info@rossin.it – T +39 0471 881488

rossin.it